

DPB02 - PPB02



True RMS 3-Phase voltage monitoring relay



Benefits

- **Wide voltages and frequency ranges.** Working in systems from 208 to 480 VAC and 50 to 400Hz.
- **Adjustable voltage asymmetry level and time delay.** To allow a correct response to real alarm conditions.
- **Output and status LED indication.** For quick troubleshooting.
- **Two mounting versions.** Available for DIN-rail (DPB02) and Plug-in (PPB02) mounting.
- **Adjustable power ON delay.** To avoid nuisance tripping at start-up.
- **Ultra-high harmonic immunity.** For very noisy environments.

Description

DPB02 and PPB02 are 3-phase mains monitoring relays.

They operate on 3P and 3P+N systems, monitoring phase loss, phase sequence and voltage asymmetry.

Power supply provided by the monitored mains.
Delay on alarm, up to 30s, for asymmetry alarm.

Applications

DPB02 and PPB02 offer solutions for a wide range of applications: lifts, escalators, HVAC, material handling, pumps, compressors and mobile machinery installations.

Main functions

- Monitoring 3-phase mains with 3 wires (3P) or 4 wires (3P+N).
- Detection of the correct phase sequence and phase loss.
- Front dial adjustable voltage asymmetry setpoint.
- Time delay.
- Changeover relay output.

▶ Structure

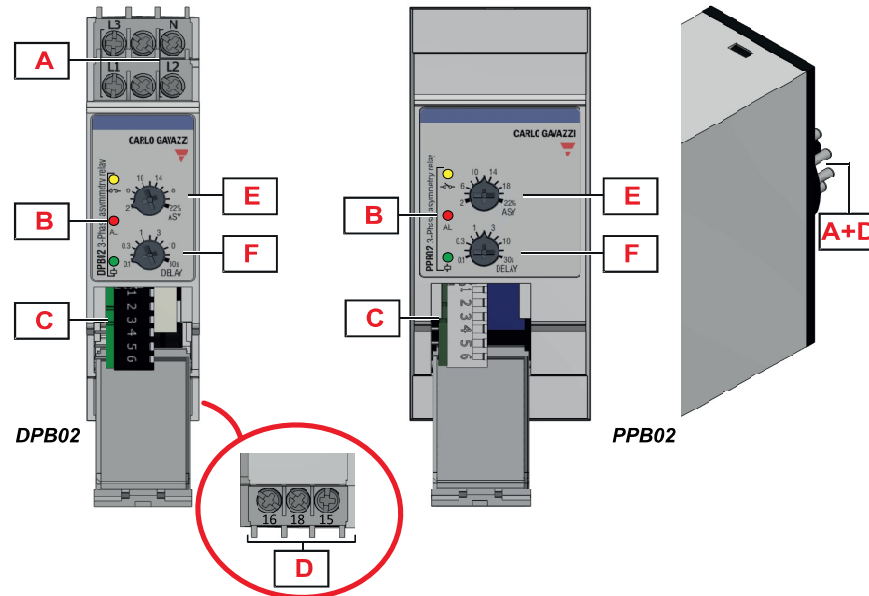

Element	Component	Function
A	Input terminals	Connection of the line voltages (neutral when present)
B	Information LED	Yellow for relay output status Red to signal alarm status Green for device ON
C	DIP-switches	Setting the nominal voltage, type of mains, power ON delay
D	Output terminals	SPDT relay output
E	Asymmetry setpoint dial	Asymmetry setpoint adjustment
F	Delay time dial	Setting the alarm ON delay time



Features

General

Material	PA66 or Noryl
Colour	RAL7035 (light grey)
Dimensions d x h x w	DPB02: 99.5mm x 80mm x 22.5mm (3.92" x 3.15" x 0.886") PPB02: 94mm x 80mm x 36mm (3.7" x 3.15" x 1.42")
Protection degree	IP20
Weight	150 g (5.29oz)
Terminals	Cable size from 0.05mm ² to 2.5mm ² (AWG30 to AWG13), stranded or solid
Tightening torque	Max. 0.5Nm (4.425lb.in)
Terminal type	Double cage screw terminals (DPB02), Undecal Plug-in terminals (PPB02)

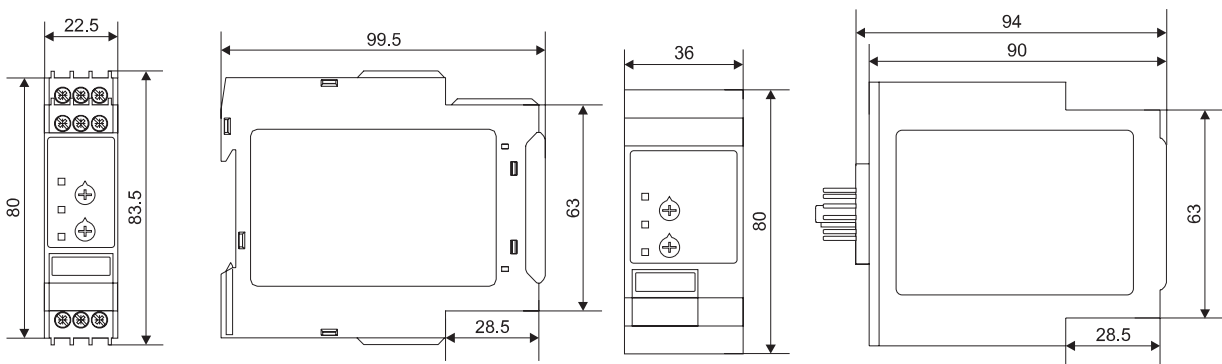

Power supply

Power supply	Supplied by measured phases	
Overvoltage category	III (IEC 60664)	
Voltage range	M23	208 to 240 V _~ AC ±15% (177V to 276V)
	M44	208 to 480 V _~ AC ±15% (177V to 552V)
	P.....M48	380 to 415 V _~ AC ±15% (323V to 477V)
	D.....M48	380 to 480 V _~ AC ±15% (323V to 552V)
Frequency range	50Hz to 60Hz ±10% sinusoidal waveform M44 only: 50Hz to 400Hz ±10% sinusoidal waveform	
Consumption	< 2.5 VA	
Power ON delay	1 s ± 0.5 s or 6 s ± 0.5 s	



▶ Environmental

Operating temperature	-20° C to 60° C (-4° F to 140° F)
Storage temperature	-30° C to 80° C (-22° F to 176° F)
Relative humidity	5-95% non condensing
Pollution degree	2
Operating max altitude	2000 m amsl (6560ft)
Salinity	Non saline environment
UV resistance	No



Vibration/Shock resistance

Test condition	Test	Level
Tests with unpacked device	Vibration response (IEC60255-21-1)	Class 1
	Vibration endurance (IEC 60255-21-1)	Class 1
	Shock (IEC 60255-21-2)	Class 1
	Bump (IEC 60255-21-2)	Class 1
Tests with packed device	Vibration random (IEC60068-2-64)	Class 1
	Shock (IEC 60255-21-2)	Class 1
	Bump (IEC 60255-21-2)	Class 1

Class 1: monitoring devices for normal use in power plants, substations and industrial plants and for normal transportation conditions.

The packaging type is designed and implemented in such manner that the severity class parameters will not be exceeded during transportation.

▶ Compatibility and conformity

CE-marking	 According to EN 60947-5-1. Complies to European LV directive 2014/35/EU and EMC directive 2014/30/EU: Immunity according to EN61000-6-2; Emissions according to EN61000-6-3
Approvals	 ULSTED (UL508, UL61010)  (GB/T14048.5) DPB02 only

Inputs

Measuring ranges	
Measured variables	Phase sequence Phase loss Asymmetry 3P: voltages $V_{L12}, V_{L23}, V_{L31}$ 3P+N: voltages $V_{L1N}, V_{L2N}, V_{L3N}$
Nominal line range	208 VAC to 480 VAC $\pm 15\%$ (177 VAC to 550 VAC)
Nominal voltages (*)	M23 3P: 208V, 220V, 230V, 240V (delta voltage) 3P+N: 120V, 127V, 133V, 140V (star voltage)
	M44 3P: 208V, 220V, 230V, 240V, 380V, 400V, 415V, 480V (delta voltage) 3P+N: 120V, 127V, 133V, 140V, 220V, 230V, 240V, 277V (star voltage)
	M48 3P: 380V, 400V, 415V, 480V (delta voltage) 3P+N: 220V, 230V, 240V, 277V (star voltage)

(*) **Note:** connect the neutral only if it is intrinsically at the star centre.

Outputs

Number of outputs	1
Type	SPDT electromechanical relay with change-over contacts
Logic	Output de-energized on alarm
Contact rating	AC1: 8 A @ 250 VAC AC15: 2.5 A @ 250 VAC DC12: 5 A @ 24 VDC DC13: 2.5 A @ 24 VDC
Electrical lifetime	$\geq 50 \times 10^3$ operations (at 8 A, 250 V, $\cos \varphi = 1$)
Mechanical lifetime	$> 30 \times 10^6$ operations
Assignment	Associated to all alarm types

Insulation

Terminals	Basic insulation
Inputs: L1, L2, L3, N (DPB02) / 5, 6, 7, 11 (PPB02) to Output: 15, 16, 18 (DPB02) / 1, 3, 4 (PPB02)	2.5kVrms, 4kV impulse 1.2/50us (basic)



Operating Description

Device configuration

The relay operates when all the phases are present, the phase sequence is correct and the asymmetry is below the set limit.

Asymmetry is an indicator of the mains quality and it is defined as the absolute value of the maximum deviation among the mains voltages, divided by the nominal voltage of the 3-phase system. The definition changes according to the voltage reference:

Mains type	Voltage asymmetry (%)
3P	$\frac{\max \Delta V_{ph-ph} }{V_{\Delta NOM}} \times 100$
3P+N	$\frac{\max \Delta V_{ph-n} }{V_{\Delta NOM}} \times 100$

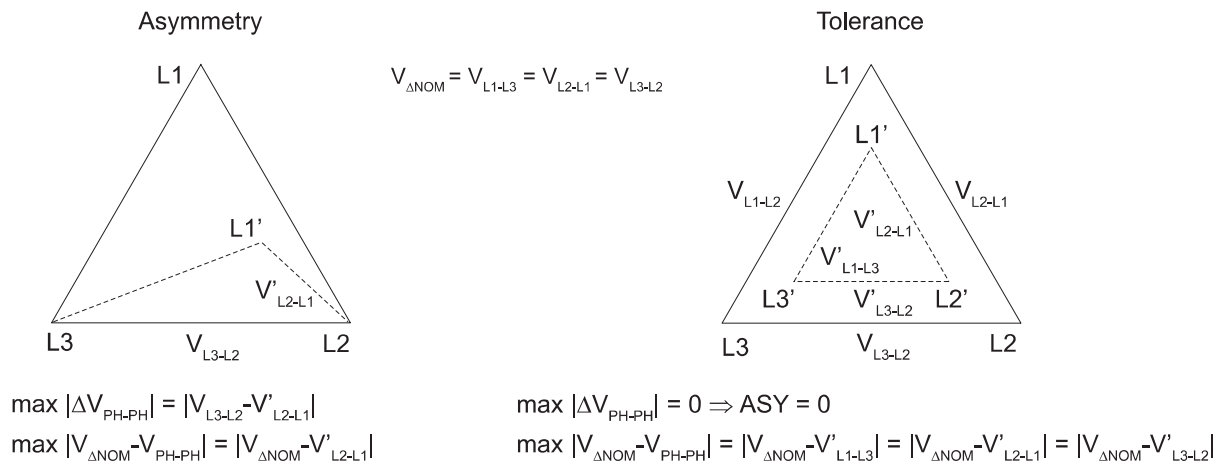

Fig. 1 Phase-phase monitoring

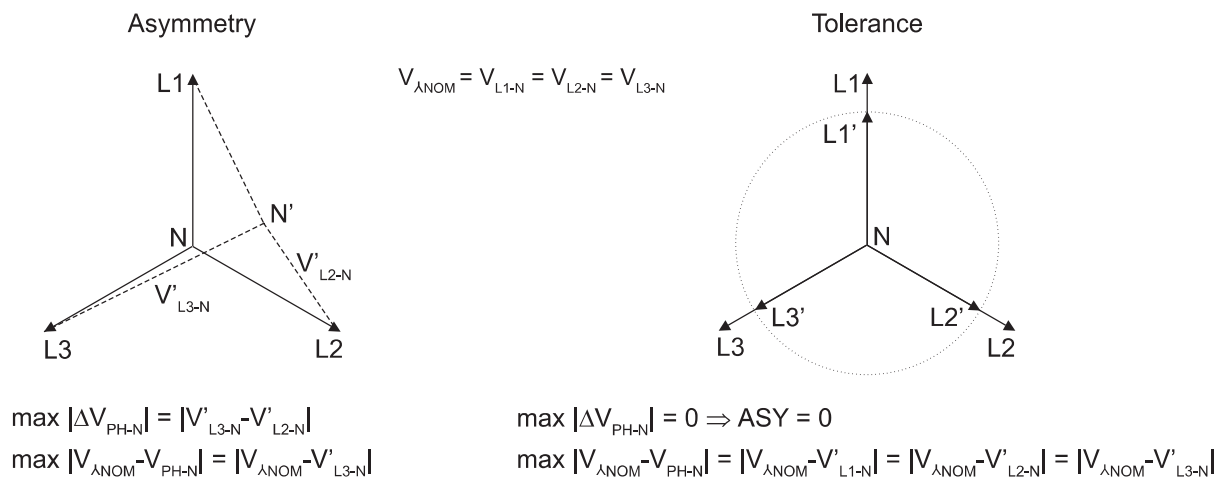
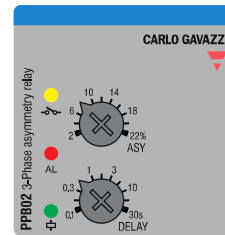
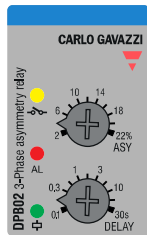

Fig. 2 Phase-neutral monitoring



Asymmetry adjustment dial	
Typology	Linear selection from 2% to 22%
Resolution	2% setpoint increase per notch
Function	Asymmetry setpoint

Delay setting dial	
Typology	Logarithmic adjustment from 0.1s to 30s
Resolution	From 100ms/notch at 0.1s to 10s/notch at 30s
Function	Alarm ON delay setting for asymmetry



DIP-switches		
Typology	M44	6 switches (switch number 6 is unused) (Fig.3)
	M23, M48	4 switches (Fig. 4 and 5)
Function	- Power ON delay - Mains type - Mains voltage (M44: 8 ranges; M23 and M48: 4 ranges)	

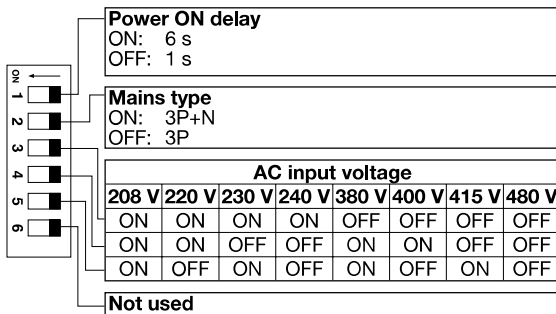

Fig. 3 DIP switch settings table M44

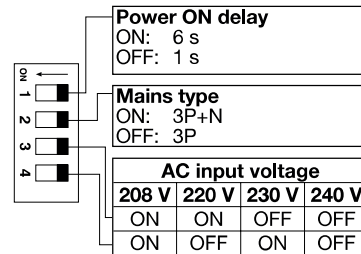

Fig. 4 DIP switch settings table M23

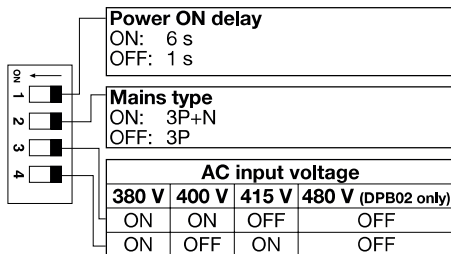

Fig. 5 DIP switch settings table M48

► Alarms

DPB02 and PPB02 operate in 2 different modes depending upon the alarm type:

- Phase loss and incorrect phase sequence cause immediate output relay de-energisation.
- Asymmetry triggering causes output relay to turn OFF at the end of set delay.



Asymmetry alarm	
Input variables	3P: voltages V_{L12} , V_{L23} , V_{L31} 3P+N: voltages V_{L1N} , V_{L2N} , V_{L3N}
Reaction time	$\leq 200\text{ms} + \text{set delay ON alarm}$
Asymmetry setting range	From 2% to 22%
Repeatability	0.5% reading
Hysteresis	Setpoint between 2% and 5% \rightarrow Hys 1% Setpoint between 5% and 22% \rightarrow Hys 2%
Delay ON	Adjustable from 0.1s to 30s Accuracy: from $\pm 50\text{ms}$ at 0.1s to $\pm 5\text{s}$ at 30s Repeatability: from $\pm 10\text{ms}$ at 0.1s to ± 1 at 30s
Delay OFF	None

Phase loss alarm	
Input variables	Voltage measurements L1-L2, L2-L3 and L3-L1
Alarm setpoint	One phase $\leq 85\%$ of the rated value (regeneration voltage detection)
Restore setpoint	All phases $> 85\%$ of the rated value + Hysteresis
Reaction time	$\leq 200 \text{ ms}$
Hysteresis	2% fixed
Delay ON	None
Delay OFF	None

Phase sequence alarm	
Input variables	Connection L1, L2, L3
Reaction time	$\leq 200 \text{ ms}$
Delay ON	None
Delay OFF	None

► Visual information

DPB02 and PPB02 feature 3 front LEDs which provide operation status information.

- Green LED is ON when the power supply is present.
- Red "AL" LED provides alarm status information: when an asymmetry alarm is triggered, and there is a delay on alarm elapsing, the LED blinks at 2Hz during the delay. If the alarm situation is still present at the end of delay, the LED turns steady ON.

If a phase is lost or the phase sequence is incorrect, the LED flashes fast at 5Hz.

- Yellow LED is ON when the output relay is energised.



Operating diagram

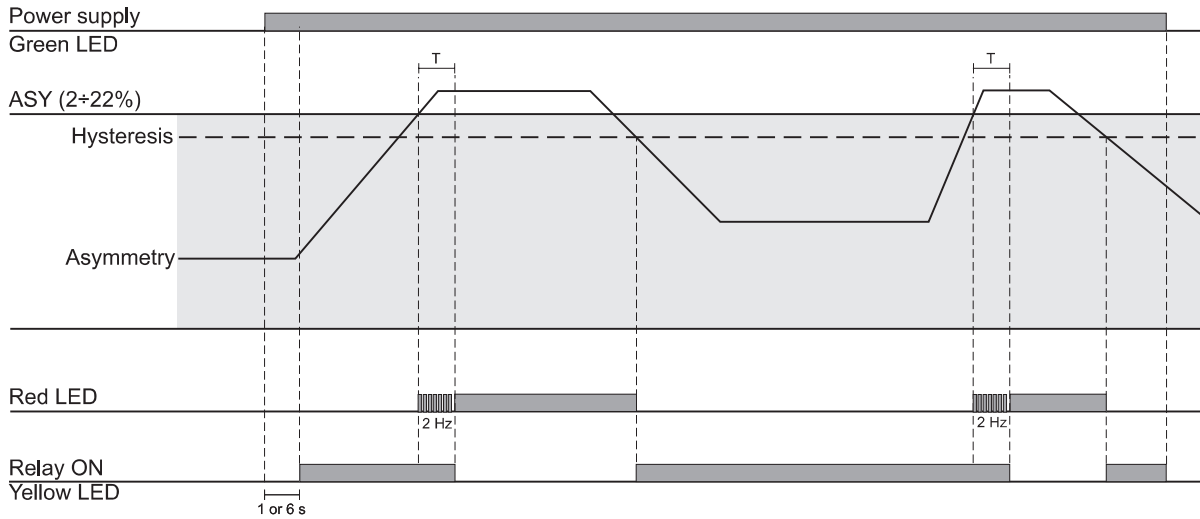

Fig. 6 Asymmetry monitoring

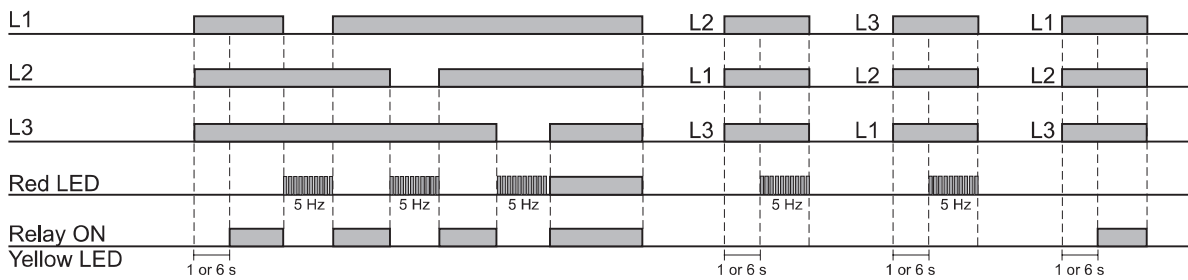

Fig. 7 Phase sequence and phase loss monitoring



Connection Diagrams

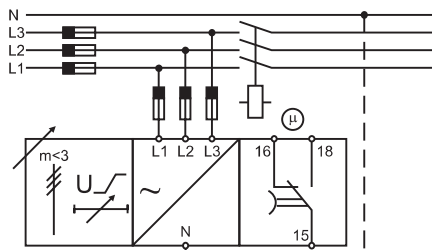

Fig. 8 DPB02 - Example 1

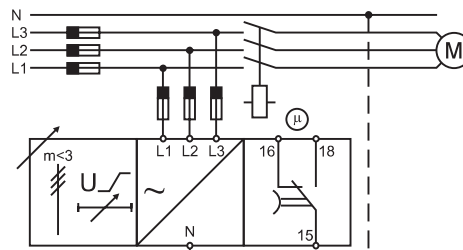

Fig. 9 DPB02 - Example 2

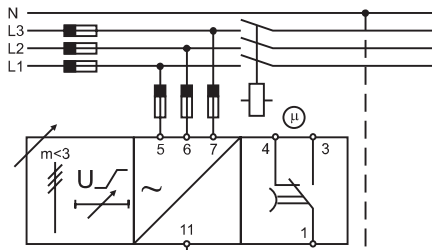

Fig. 10 PPB02 - Example 1

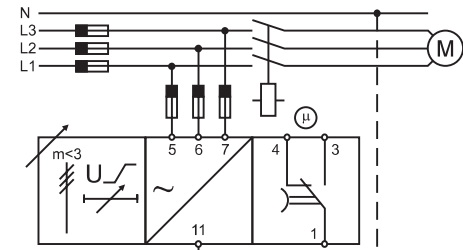

Fig. 11 PPB02 - Example 2

References

Order code

 PB02C

Complete the code entering the corresponding option instead of

Code	Option	Description
<input type="checkbox"/>	D	DIN rail housing
	P	Plug-in housing
P	-	3-phase voltage
B	-	Extended functions
02	-	Item number
C	-	SPDT relay output
<input type="checkbox"/>	M23	Power supply
	M44	
	M48	

Component name/part number	Mounting	Frequency	Power supply
DPB02CM23	DIN rail housing	50 - 60 Hz	208 to 240 VAC
PPB02CM23	Plug-in housing	50 - 60 Hz	208 to 240 VAC
DPB02CM44	DIN rail housing	50 - 400 Hz	208 to 480 VAC
PPB02CM44	Plug-in housing	50 - 400 Hz	208 to 480 VAC
PPB02CM48	Plug-in housing	50 - 60 Hz	380 to 415 VAC
DPB02CM48	DIN rail housing	50 - 60 Hz	380 to 480 VAC



COPYRIGHT ©2020
Content subject to change. Download the PDF: www.productselection.net